



Gates CARBON DRIVE™

OWNER'S MANUAL

CLEAN
QUIET
LIGHT
STRONG



WARNING



Read this entire manual before using, replacing, or installing the Gates Carbon Drive belt. Improper installation, adjustment, alteration, service, or maintenance can result in property damage and serious bodily injury, including death. Refer to this manual for assistance or consult with a cycling professional for further information.

Gates requires a hand brake as the primary braking system.

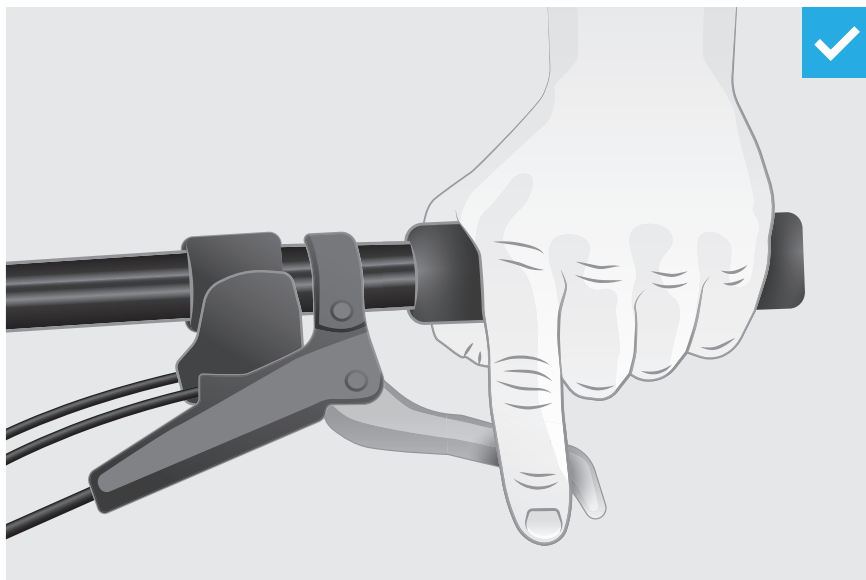

HANDLING THE BELT

Do not crimp, twist, backbend, invert, bundle or zip tie the belt. Do not use the belt as a strap wrench or chainwhip. Do not roll on or pry on the belt. [See page 4.](#)

Gates requires a hand brake as the primary braking system.

BELT TENSION AND DRIVE ALIGNMENT

Proper tension and drive alignment is key to optimal performance.

- Lack of belt tension can lead to “skipping”. Too much tension can damage other components and increase the wear of your Carbon Drive System.
- Signs of a misaligned drive include, but are not limited to, noise, premature belt or sprocket wear, belt walk-off. Detailed information and schematics can be found in our Technical Manual located at www.gatescarbondrive.com/tech/resources. You can also contact us directly via email at: carbondrive@gates.com.

CARE FOR YOUR CARBON DRIVE

- Wash with water to remove debris.
- Acceptable temperature range for CDX and CDC belts is -65° F (-53° C) to +185° F (+85° C).
- Acceptable temperature range for the CDN system is -4° F (-20° C) to +140° F (+60° C).
- Do not lubricate.
- If your bike is equipped with a snubber, the snubber must not be in contact with the belt.
- This is a drive system – it is imperative to keep bodily parts and clothing away from the drive while in motion.

Improper installation, adjustment, alteration, service, or maintenance can result in property damage and serious bodily injury, including death. Refer to this manual for assistance or consult with a cycling professional for further information.

HANDLING THE BELT

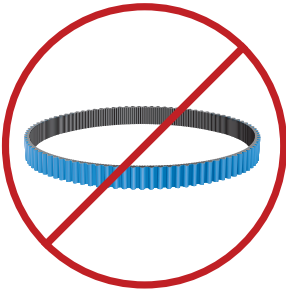
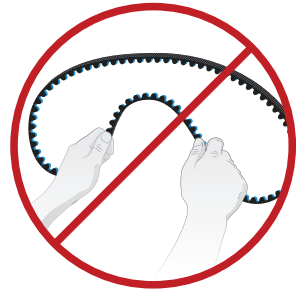
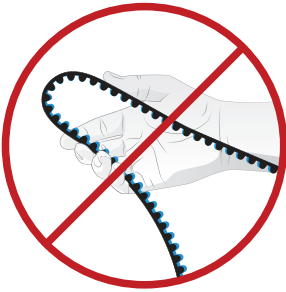

DO NOT ROLL ON

DO NOT PRY ON



LESS NOISE. LESS MAINTENANCE. A WHOLE LOT MORE FUN.

We are thrilled and honored that you have chosen a bicycle equipped with Gates Carbon Drive™. We hope you enjoy the difference Clean, Quiet, Light and Strong will mean for your ride. This manual explains the performance benefits of the system, information about proper care and tensioning, as well as warranty instructions.

- 3 General Safety**
- 4 Handling the Belt**
- 6 What is Gates Carbon Drive?**
- 7 Why Gates Carbon Drive?**
- 8 Care for your Carbon Drive System**
- 10 Proper Tension is Key**
- 13 Proper Alignment**
- 14 Replace When Worn**
- 16 Rear Wheel Removal + Installation**
- 18 Who is Gates?**
- 19 Warranty**

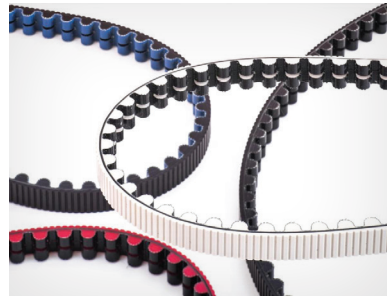

WHAT IS GATES CARBON DRIVE?

The technology behind Gates Carbon Drive System is rooted in high horsepower motorcycles and dragsters. Now, this high performance technology has been perfected for a wide variety of bicycles. At the core of the drive is the Carbon Drive belt. Custom made, this 11mm pitch, carbon-fiber belt is a strong and efficient replacement to a traditional bike chain. The drive is completed with our innovative sprocket designs and your choice of internally-geared or single-speed hub. The patented Gates Carbon Drive System gives you a longer-lasting, lower-maintenance drive, and most importantly, an unbelievably awesome ride.

CDX CENTERTRACK BELT

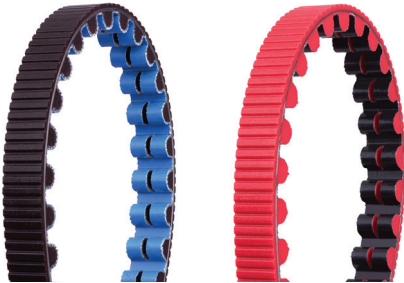

CDN CENTERTRACK BELT



CLEAN. LOW MAINTENANCE.

No lube required = no grease stains. It sheds dirt and grime and cleaning with water is easy. Just get on it and ride.

QUIET.

No chain = no chain clatter. It's spooky quiet.

LIGHT.

Gates Carbon Drive weighs less than a chain drive. Lighter weight means higher performance.

STRONG.

The instant engagement and smooth feel is unlike anything you've experienced before. You've got to ride it to believe it.

CDX + CDN BELT CONSTRUCTION

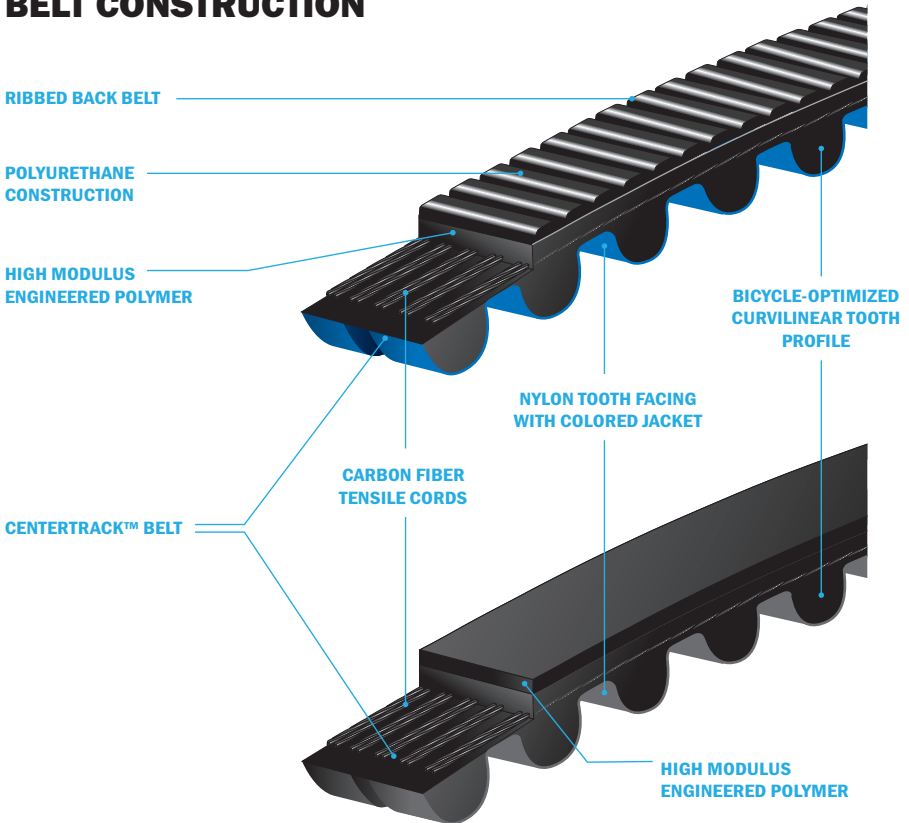

CARE FOR YOUR CARBON DRIVE

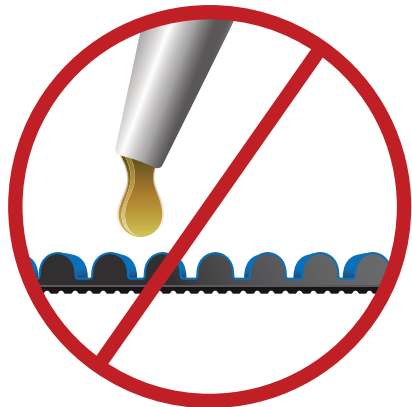
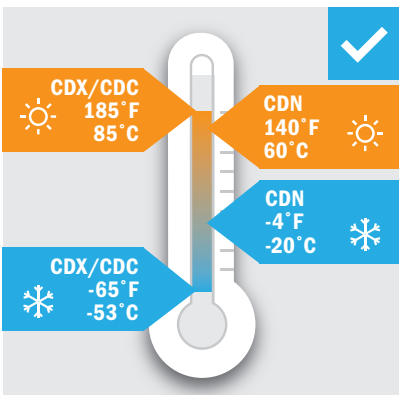
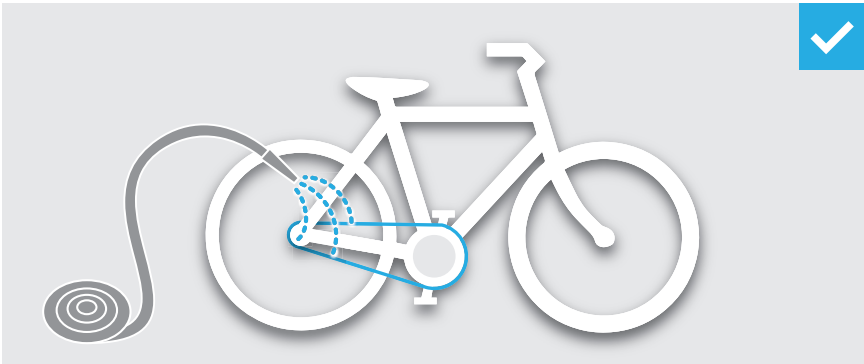
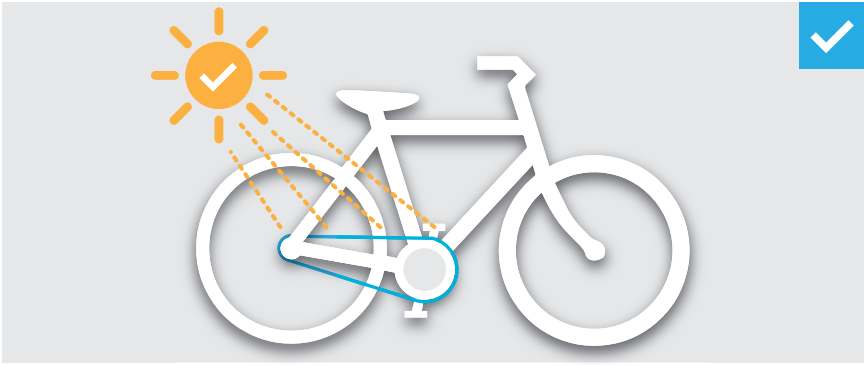

 = APPROVED

 = NO

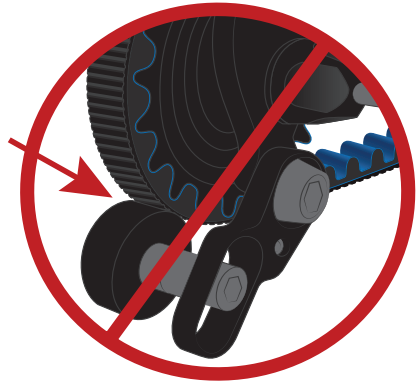
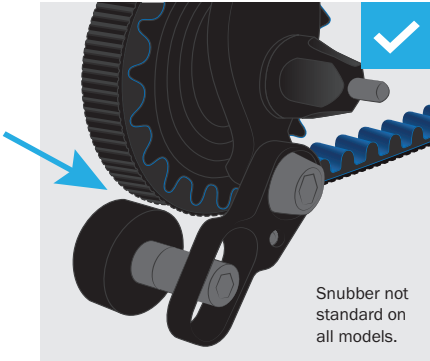

 **DANGER**

Use Caution. Although clean of grease, belt drives can still catch pants, skirts or loose clothing. Installation of a belt guard is recommended.

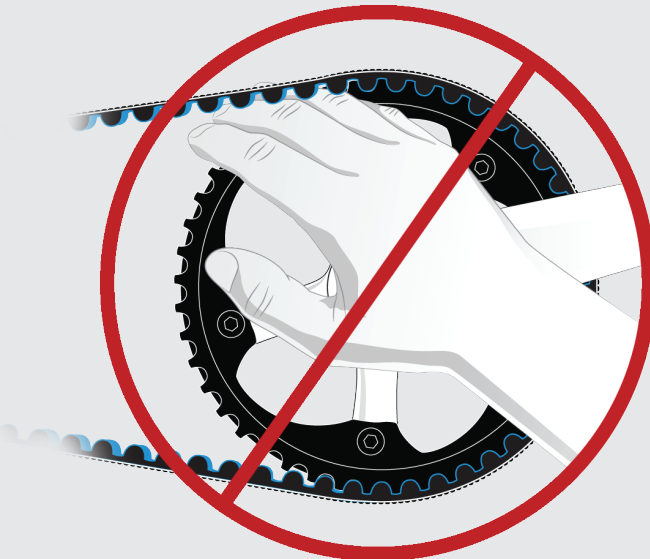

PROPER TENSION IS KEY

Proper belt tension is essential for optimum operation of the Gates Carbon Drive System. Lack of belt tension can lead to tooth jump or “skipping”, when the teeth of the belt slide over the teeth of the rear sprocket. Too much tension can damage the bearings within the rear hub, can cause the system to drag, and can increase the wear of your drive system.

Tensioning procedures vary depending on the bike. Common types of tensioning systems include sliding or pivoting dropouts and eccentric bottom brackets.

Note – Correct alignment of the belt has to be maintained as you adjust tension.

There are 3 common methods for measuring tension on your Carbon Drive system: the Gates Kriket Gauge, the Eco Tension Tester, and the Gates Carbon Drive Mobile Apps. For each of these, the tension may vary a little along the belt, so you should repeat this procedure several times. Rotate the cranks a quarter turn after each measurement and measure again.

The tools only measure tension, they do not specify a needed tension. Refer to the chart below for the correct tension range recommendation for your Gates Carbon Drive setup.

TENSION RECOMMENDATIONS		
	SMOOTH + STEADY PEDALING STYLE	PUNCHY + ROUGH PEDALING STYLE
Mountain* and SS Urban	45-60 Hz (35-45 lbs)	60-75 Hz (45-53 lbs)
Internally Geared Hub	35-50 Hz (28-40 lbs)	
Tandem	60-65 Hz (45-48 lbs)	
These tension recommendations are a good starting point, which may need to be adjusted higher or lower based on the rider size, gear ratio, and power placed on the pedals.		
* The CDN System is not approved for use on mountain bikes, mid-drive eBikes or gear boxes, fixed gear bikes, or high mileage trekking/touring bikes.		

GATES KRIKIT GAUGE (NORTH AMERICA)

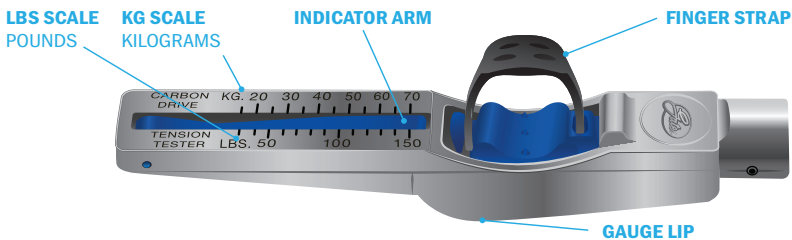

CHECKING BELT TENSION: GATES KRIKIT GAUGE (NORTH AMERICA)

1



Verify **Indicator Arm** is positioned completely down.
Place index finger in the rubber **Finger Strap**, on top of the **Click Pad**, as shown.

2

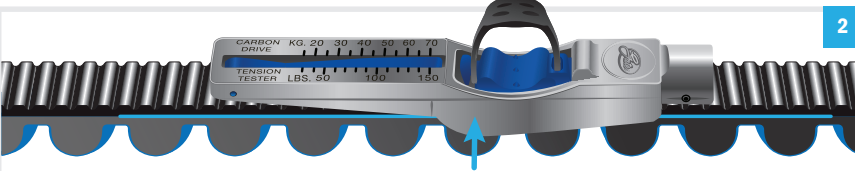

Place **Krikrit Gauge** on top of the belt and position the gauge in the middle of the total belt span, making sure the **Gauge Lip** sits flush against the belt.

3

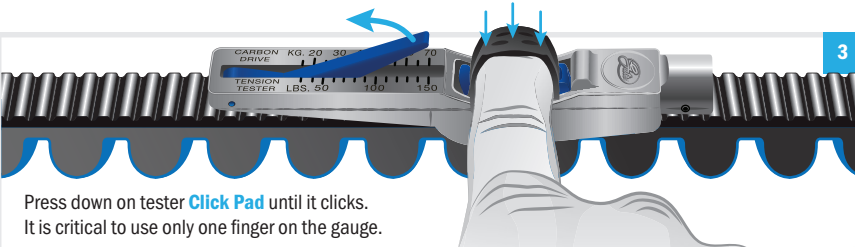

Press down on tester **Click Pad** until it clicks.
It is critical to use only one finger on the gauge.

4

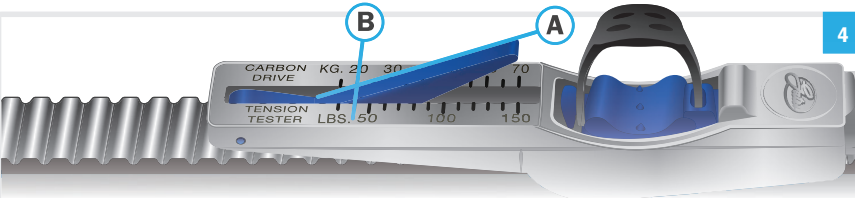

Measurement point is the intersection of lines **A** and **B**.
The gauge tension reading above is: **20 KG**

5

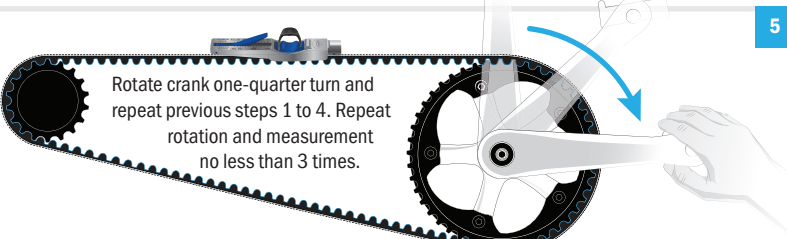

Rotate crank one-quarter turn and repeat previous steps 1 to 4. Repeat rotation and measurement no less than 3 times.

ECO TENSION TESTER



1 Hang the main tower on the belt.

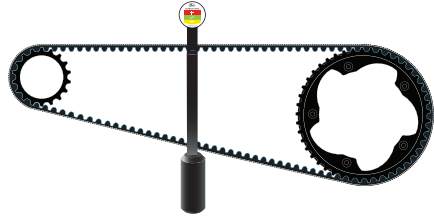

2 Put the ruler on the two sprockets. Check the tension:

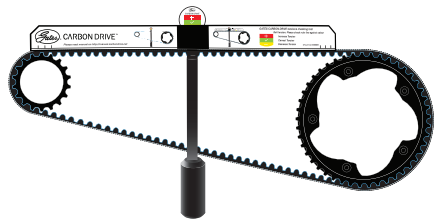

GATES CARBON DRIVE MOBILE APPS

Belt tension can also be measured with the Gates Carbon Drive Mobile Apps, offered on both iPhone and Android. These apps can measure the belt tension in the form of natural frequency (Hz) of the belt span. Operating instructions are provided within each app. Basic operating instructions are to open the app, make sure the microphone is on, and then hold the phone over the top of the belt in the middle of the span – be sure the phone's microphone is facing the belt. Pluck the belt so that it vibrates similar to a guitar string. The app will convert the sound into the primary frequency of the belt. Rotate the crank to move the belt about a $\frac{1}{4}$ turn, and repeat the measurement process. Do this for at least one full revolution of the belt. Compare your belt's frequency to the chart (pg 10) to see if you need to adjust the tension. The Carbon Drive app works best in a quiet environment.

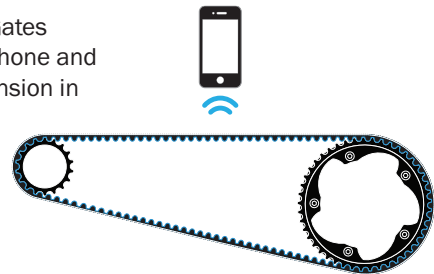

Alignment is critical, depending on the particular bike and setup, spacers may be used to ensure proper alignment. Sprockets that are out of alignment can cause noise, wear, or belt walk-off. Belt alignment refers to the parallel (side to side) and angular (toe in – toe out) alignment of the belt between the front and rear sprocket positions. Proper alignment is critical in order to maintain proper system performance. For detailed information and schematics regarding alignment, please see our Technical Manual, located at:

www.gatescarbondrive.com/tech/resources

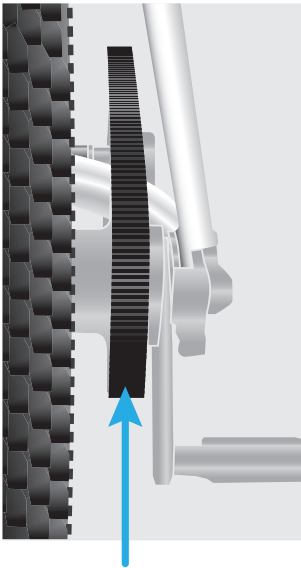

PROPER ALIGNMENT

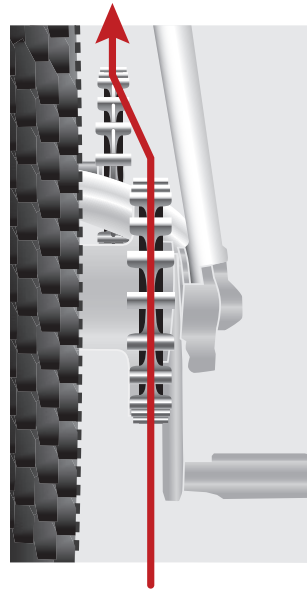

CDX SPROCKETS ARE NOT ALIGNED

REPLACE WHEN WORN

Gates Carbon Drive™ Belts and Sprockets are extremely durable and built to offer a long life, but they do wear and tear over time. Periodically, carefully inspect your belt and sprockets for signs of deterioration:

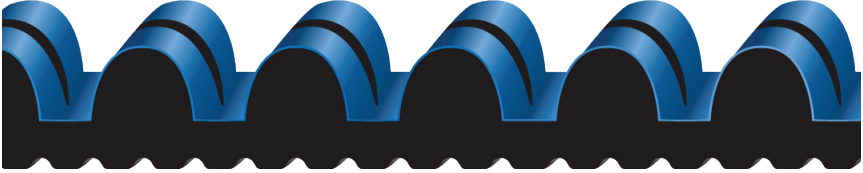

This belt is in **excellent condition**.

Loss of blue color does NOT indicate wear.

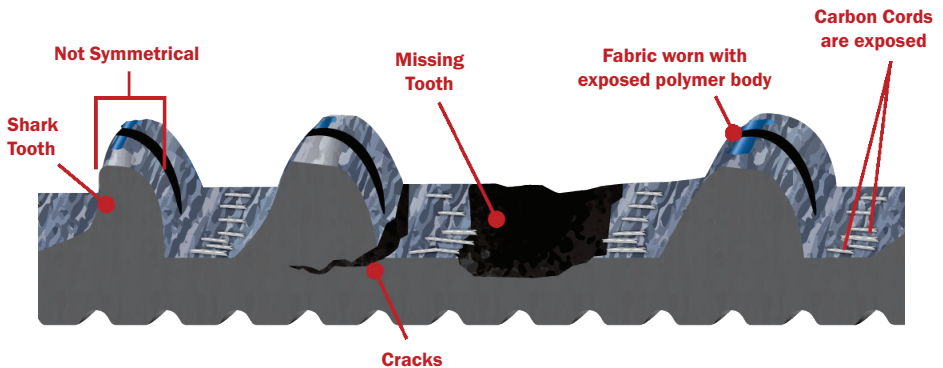

Replace your belt when it shows these signs of wear and tear.

WARNING: Using a worn or damaged Carbon Drive belt or failing to properly inspect the Carbon Drive belt before each usage can result in property damage and serious bodily injury, including death.

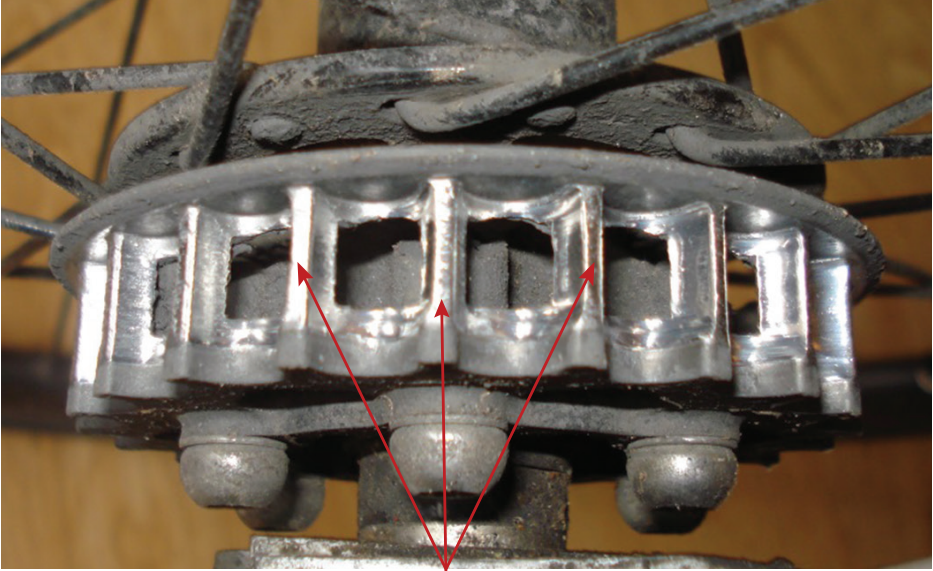

Worn MudPort Sprocket Teeth



Replace your MudPort sprockets when the teeth become worn as shown in the illustration above.

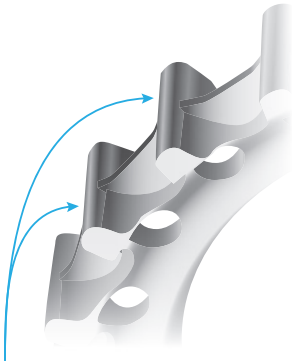

This CenterTrack Sprocket is in **excellent condition**.

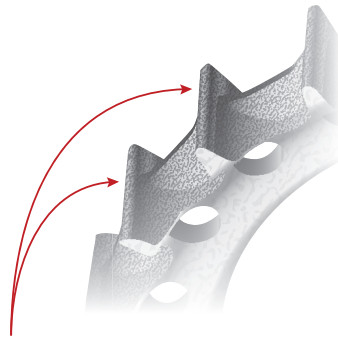

Replace your CenterTrack sprockets when the teeth become worn as shown in the illustration above.

16 | **REAR WHEEL REMOVAL & INSTALLATION**

See bike manufacturer for additional wheel removal details.

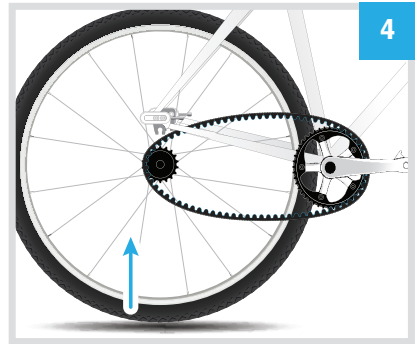

REAR WHEEL REMOVAL & INSTALLATION

See bike manufacturer for additional wheel removal details.

DO NOT ROLL ON



DO NOT PRY ON



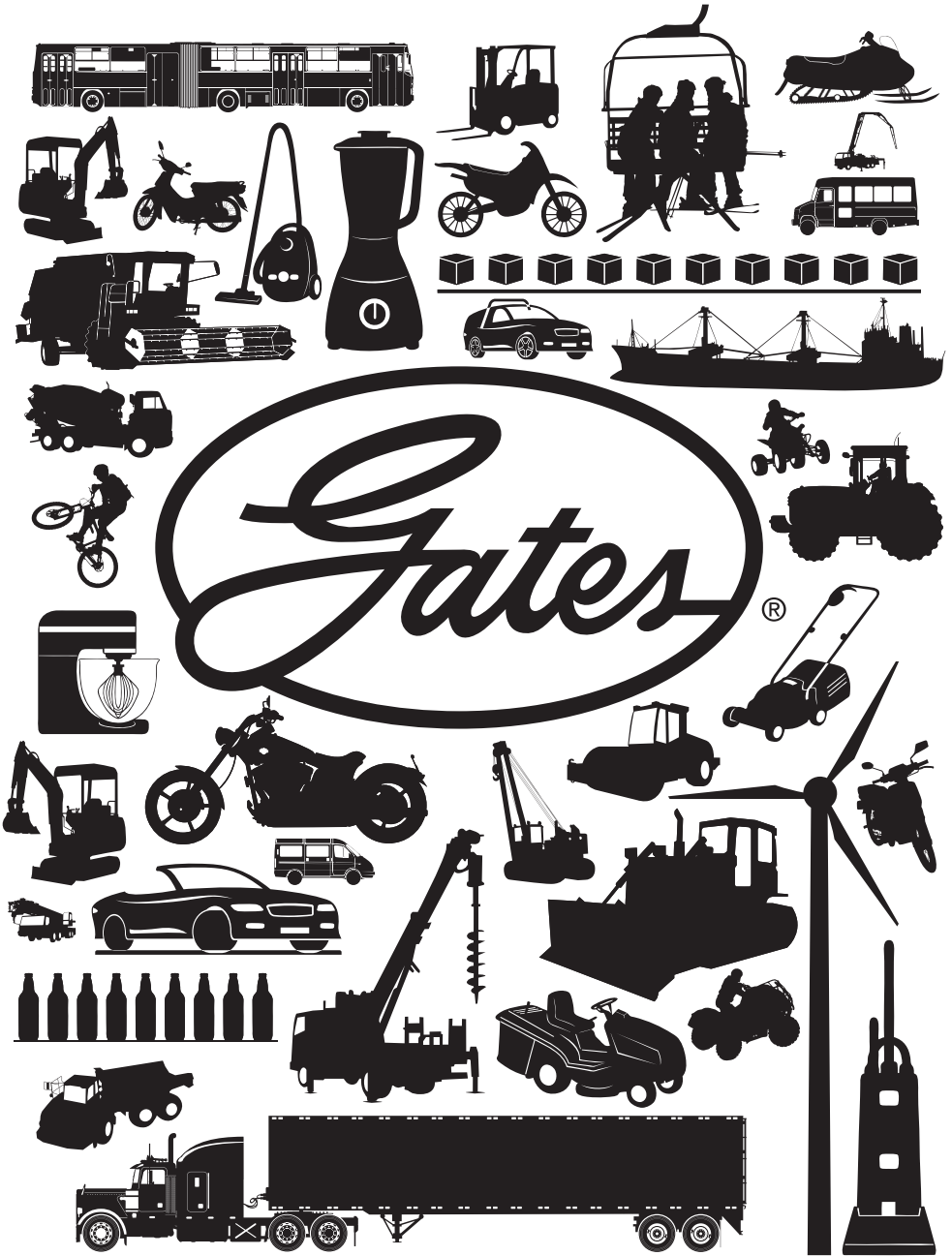

CARBON DRIVE™ SYSTEMS LIMITED PRODUCT WARRANTY

We make this quality commitment: at the time of sale to our customers, Gates Carbon Drive Systems Products (belts, sprockets, and accessories used in the bicycle market) will be free from defects in materials and workmanship. Further, the Products will meet our written specifications and standards. Products will be warranted only to the original retail purchaser for a period of two years from the original date of purchase. If we determine a product does not comply, we will, at our option, replace or repair the product. This is your exclusive remedy.

Damage to the product due to abuse, improper use, inadequate maintenance, or failure to follow Gates Carbon Drive Systems' published recommendations for installation, use and service will automatically void this warranty. Before using this product, please read the handling and installation instructions carefully (a copy of which is located at <http://www.gatescarbondrive.com/Tech/Overview>). For warranty service, please contact the retailer from whom the product was purchased.

THERE IS NO OTHER EXPRESS WARRANTY. FURTHER, WE DISCLAIM ALL IMPLIED WARRANTIES, INCLUDING THE WARRANTIES OF FITNESS FOR A PARTICULAR PURPOSE AND MERCHANTABILITY. LIABILITY FOR CONSEQUENTIAL, INCIDENTAL AND PUNITIVE DAMAGES UNDER ANY AND ALL LEGAL THEORIES IS EXCLUDED.

Some states do not allow the exclusion or limitation of damages, and some states do not allow limitations on how long a warranty lasts, so the above limitation and exclusion may not apply to you. This warranty gives you specific legal rights, and you may also have other rights which vary from state to state.

Return Policy: Gates Carbon Drive Systems Belts cannot be returned or exchanged.

For more information in Europe contact:

Gates Carbon Drive – Germany Bicycle Lab
Walkmühlenstr. 194
99974 Mühlhausen
+49 (0) 3601 888 6484
info@CarbonDrive.net

For more information in North and South America contact:

Gates Carbon Drive – Colorado Bicycle Lab
Denver, CO USA
303-744-4593
CarbonDrive@gates.com



GATES CORPORATION
CarbonDrive@gates.com
www.GatesCarbonDrive.com



©2013-2019 Gates Corporation
17571-0M 2019/01
Visit www.GatesCarbonDrive.com/OwnersManual for updates and other languages.

The color "carbon blue" is a trademark of Gates Corporation.